

Figure Headings
Chapter I, Introduction

<u>Figure No.</u>	<u>Heading</u>	<u>Page</u>
I-1	Location of Cedar Mesa and Surroundings	--
I-2	Cedar Mesa Drainages	--
I-3	West to East Transect Across Cedar Mesa	--
I-4	Climatic Summary for Natural Bridges	--
I-5	Length of Droughts a) Spring b) Fall	--
I-6	Monsoon a) Date of Inception b) Amount of Precipitation	--
I-7	Growing Season a) Date of Last Frost b) Date of First Frost c) Growing Season Length	--
I-8	Walter Climatic Diagram for Natural Bridges a) Number of years of observation b) Elevation (Meters) c) Mean annual temperature (°C) d) Mean annual Precipitation (mm) e) Humid period (Mean temperature above 0°C) f) Arid period g) Months with mean daily temperature below 0°C h) Months with minimum temperature below 0°C i) Months with minimum temperature above 0°C j) Humid period with mean temperature below 0°C	--
I-9	Walter Climatic Digrams for Mesa Verde and Betakin	--

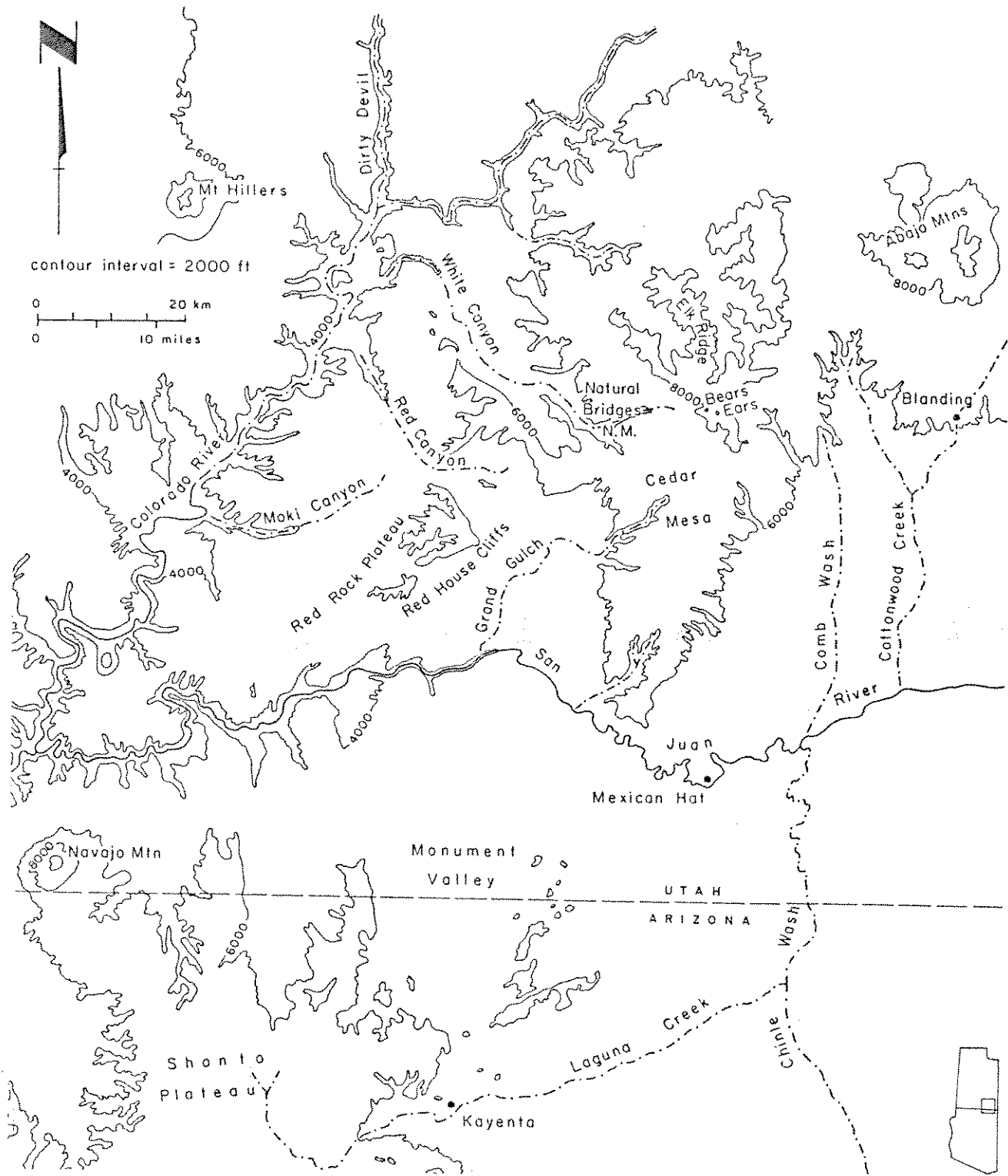

Figure I-1

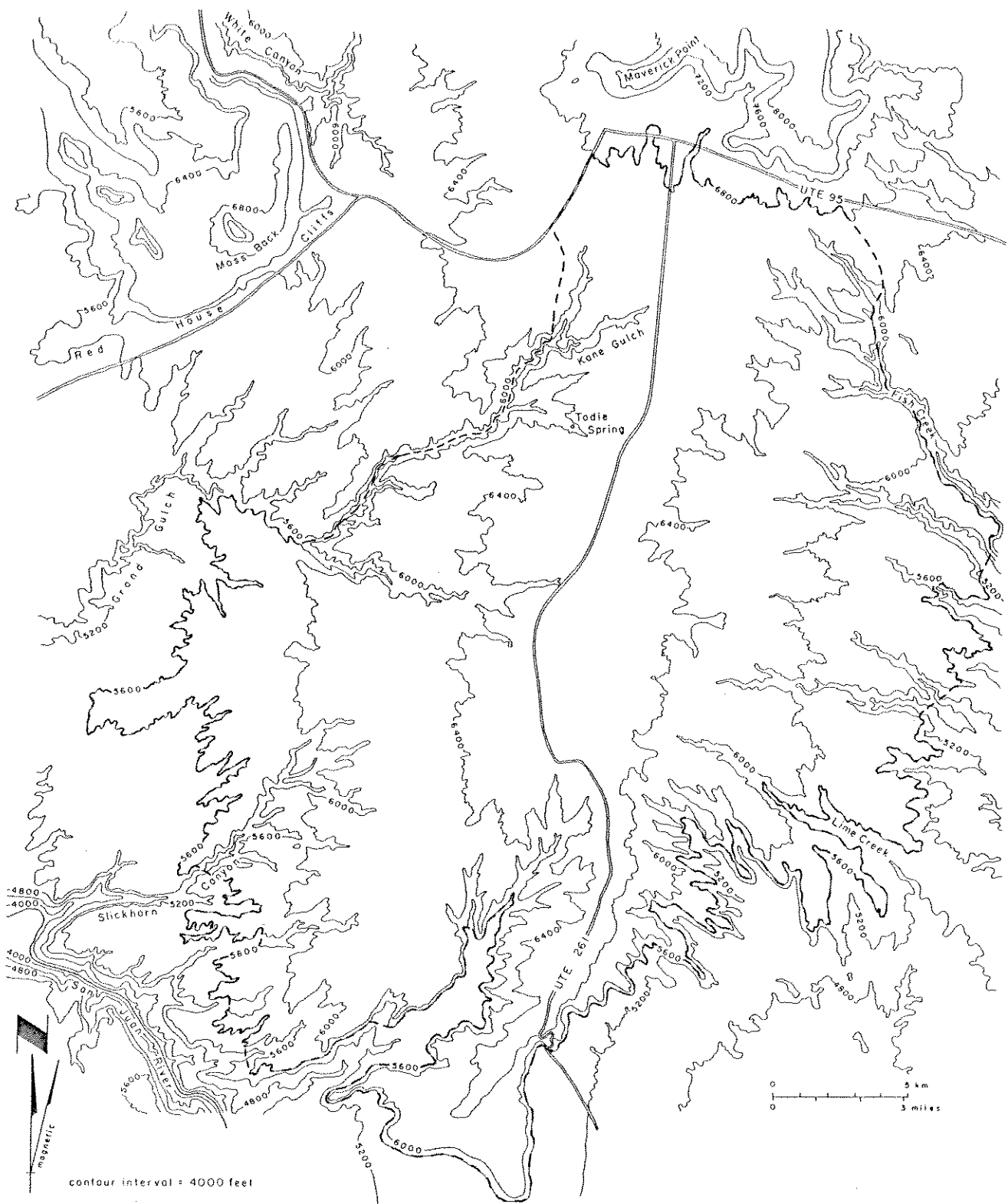

Figure I-2

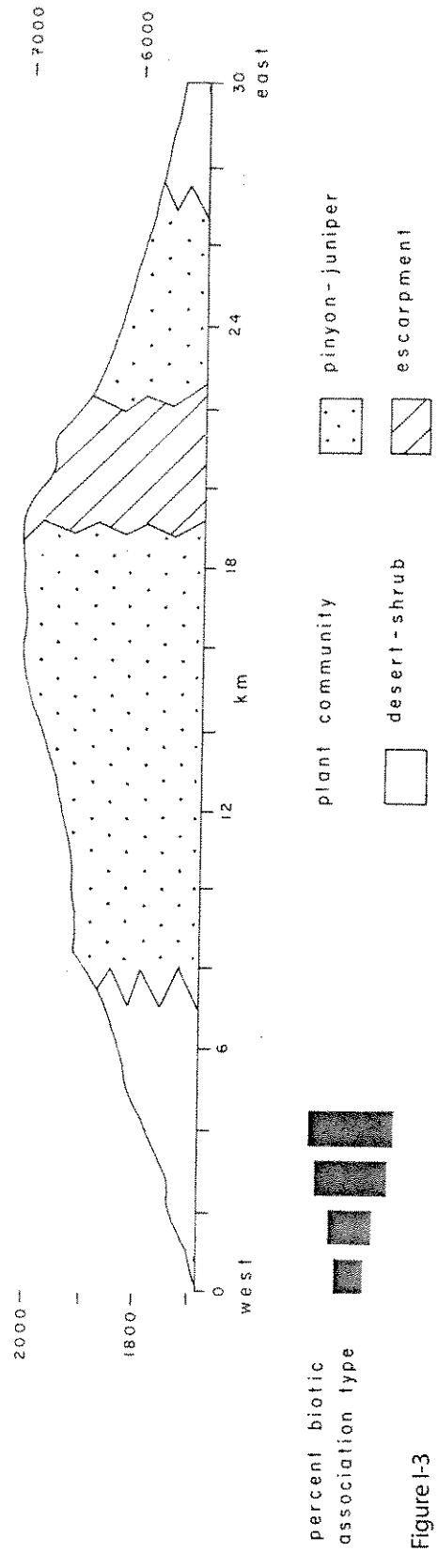
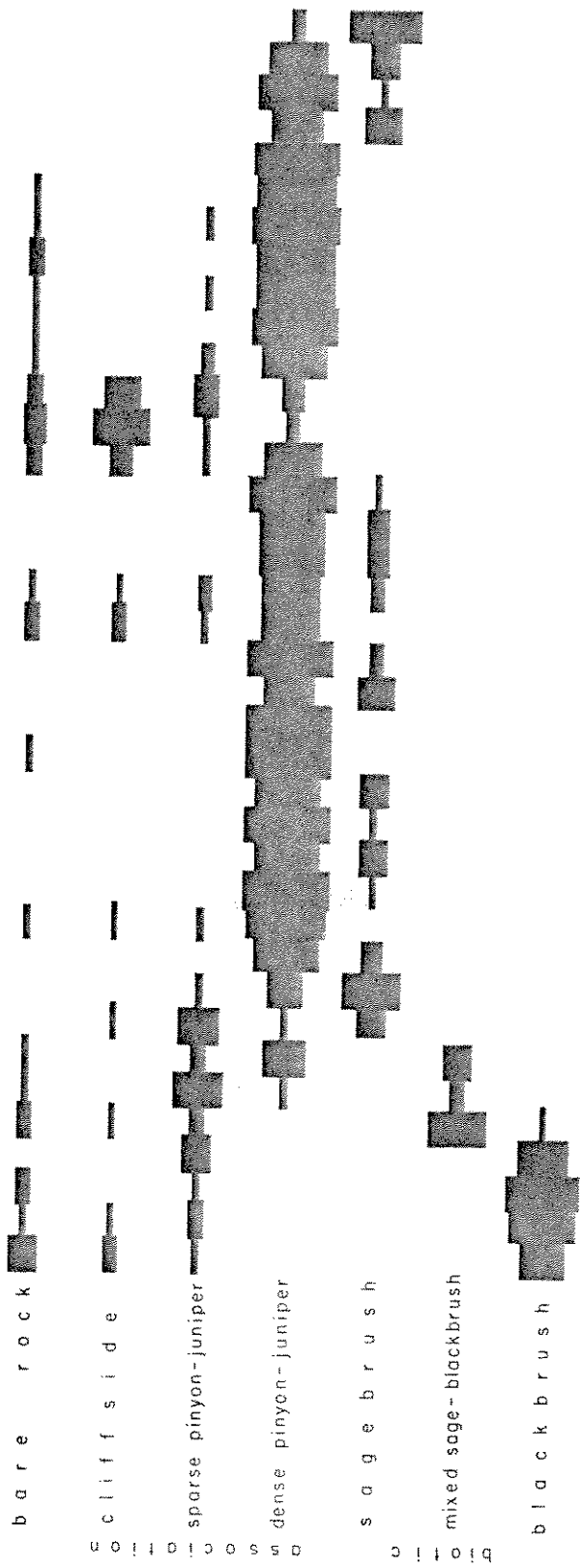

Figure 1-3

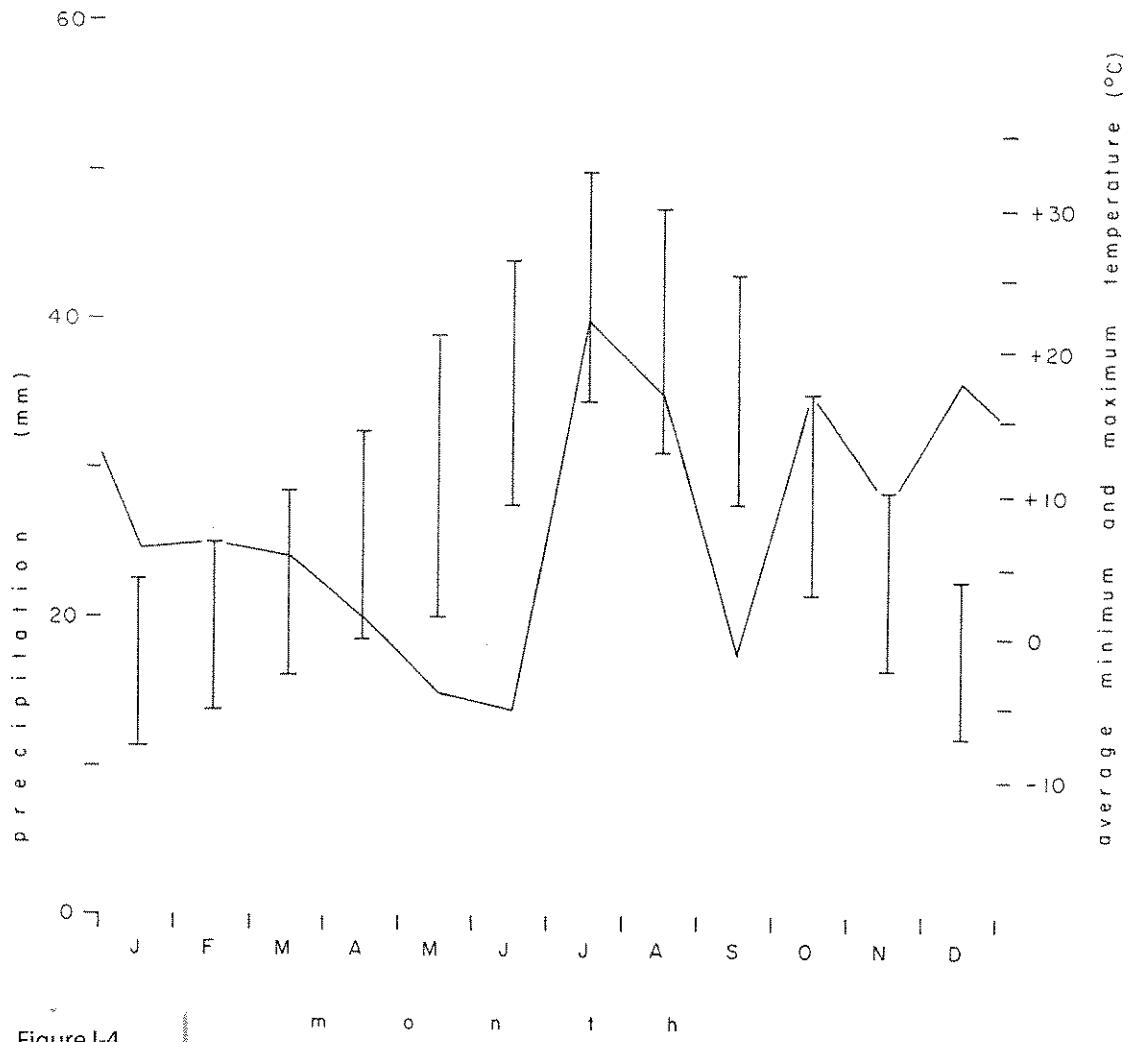

Figure I-4

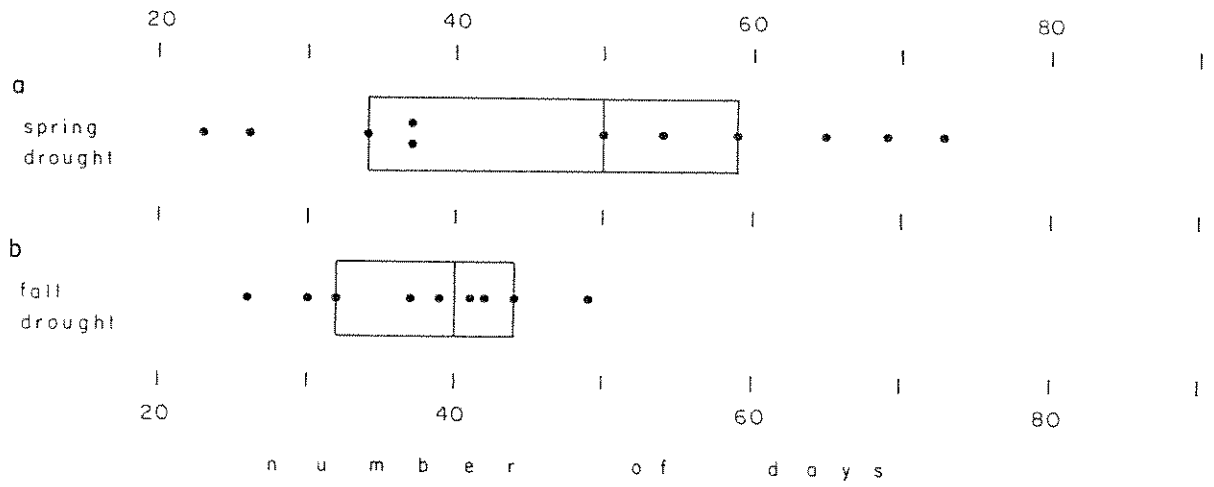

Figure I-5

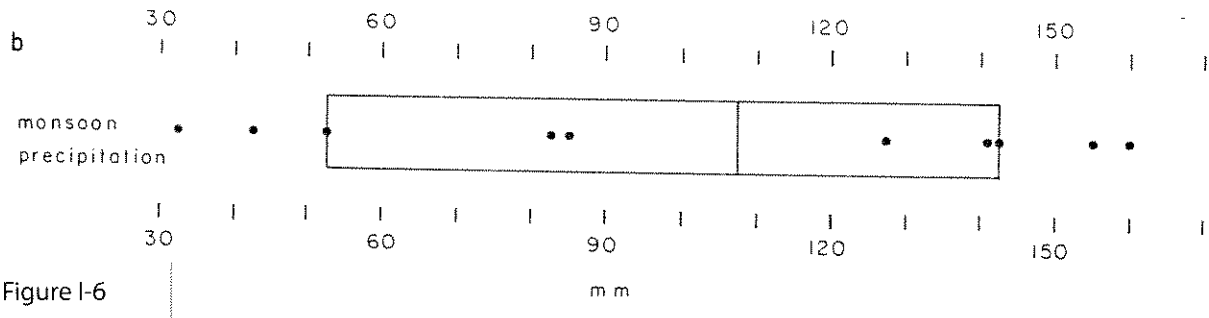
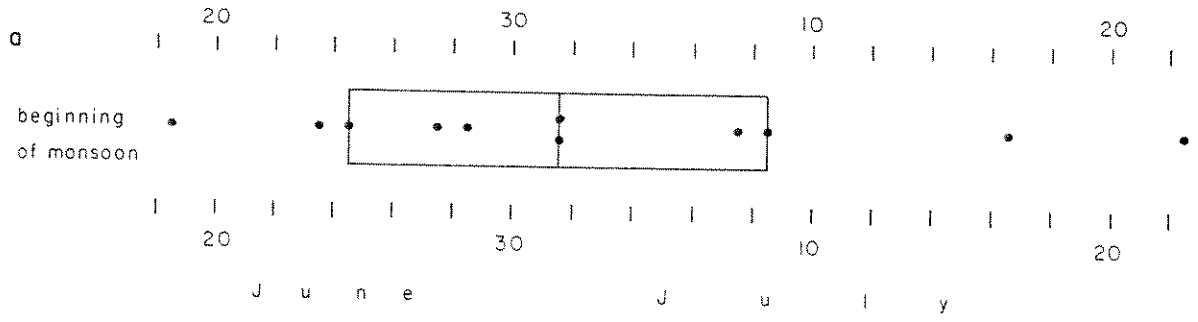

Figure I-6

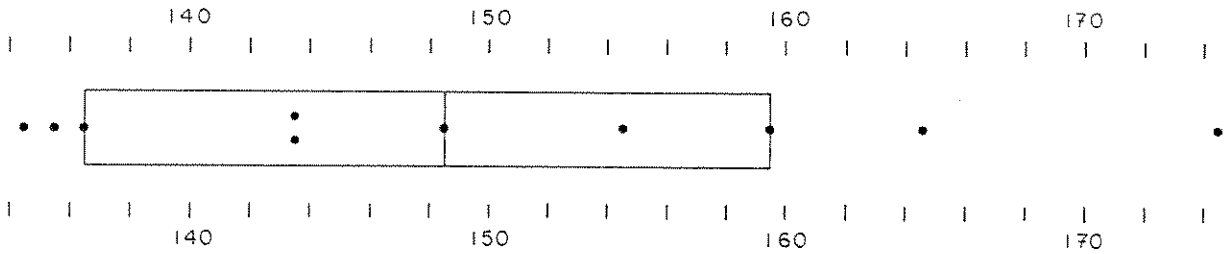
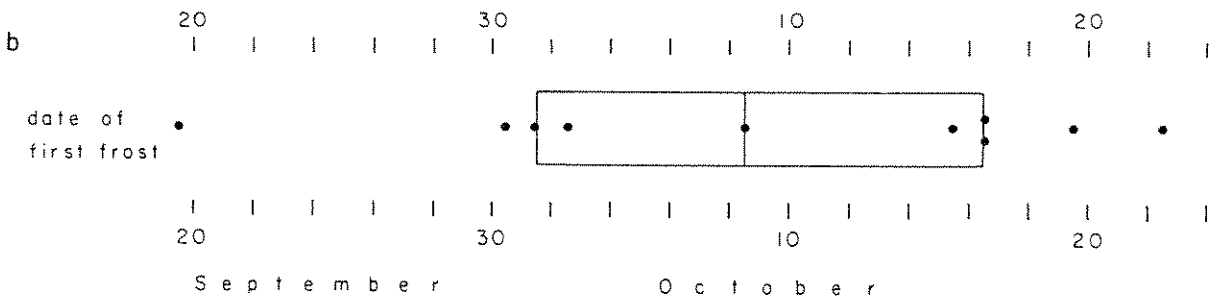
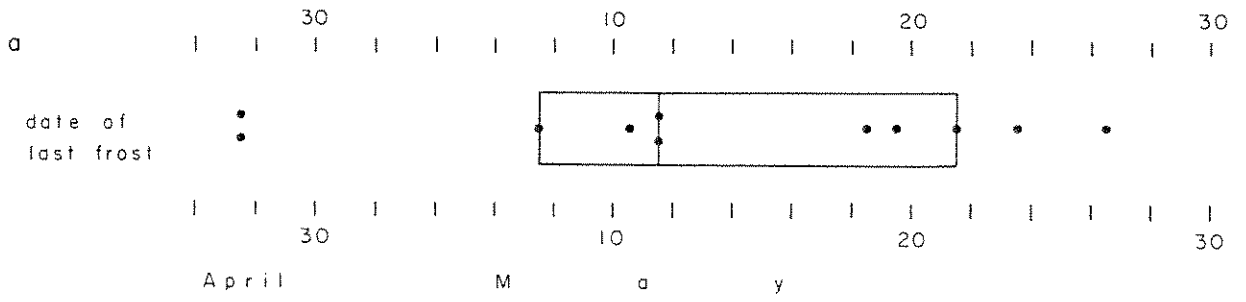

Figure I-7

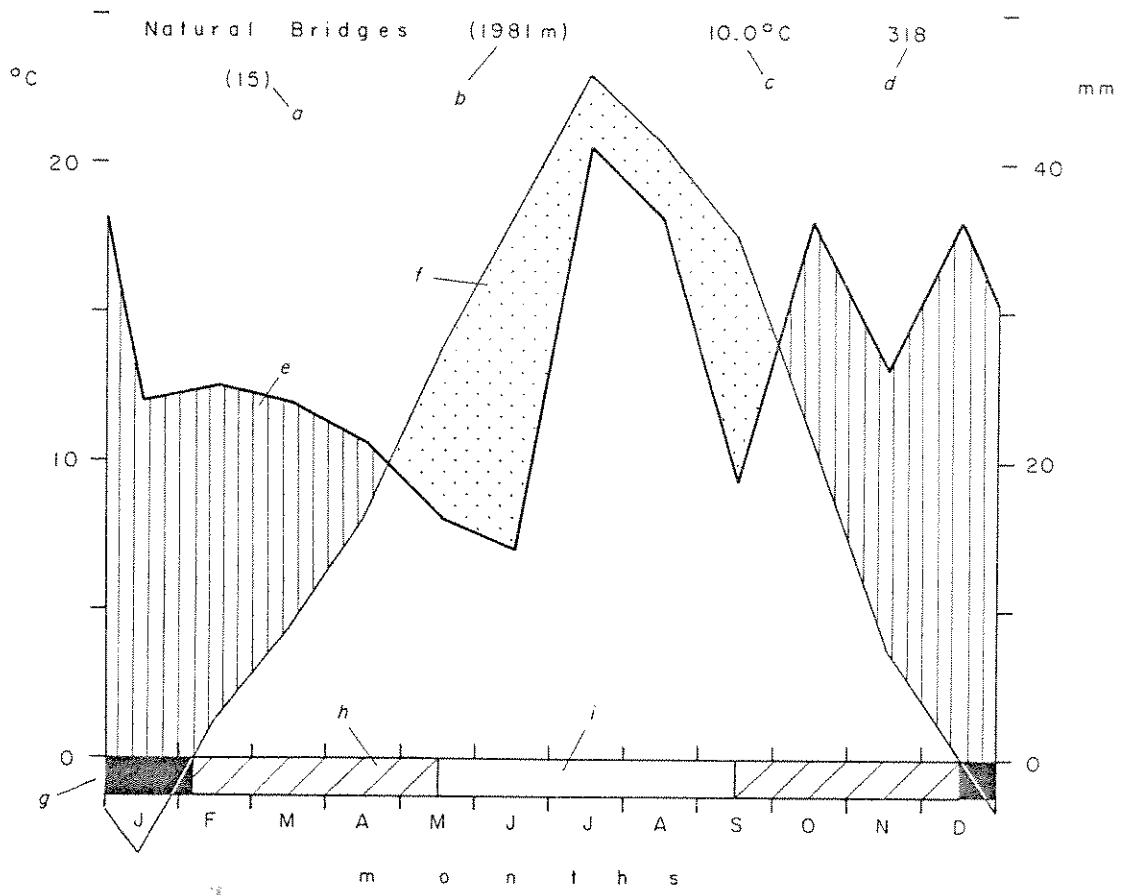

Figure I-8

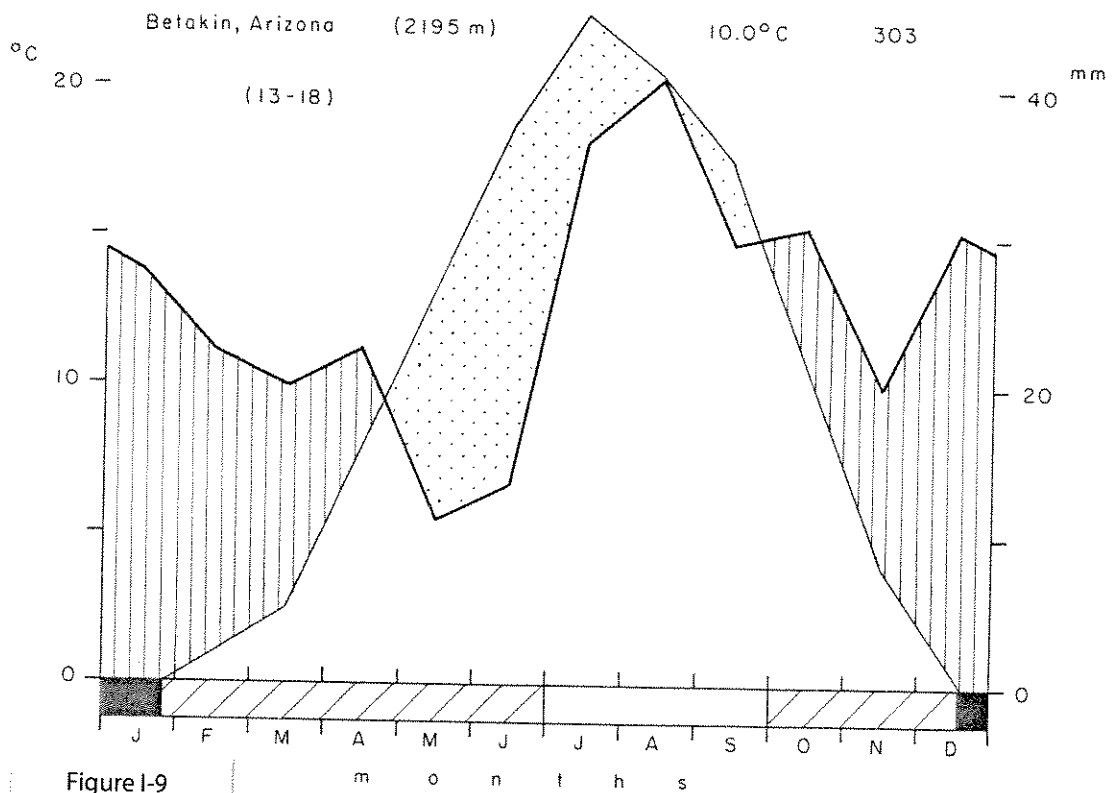
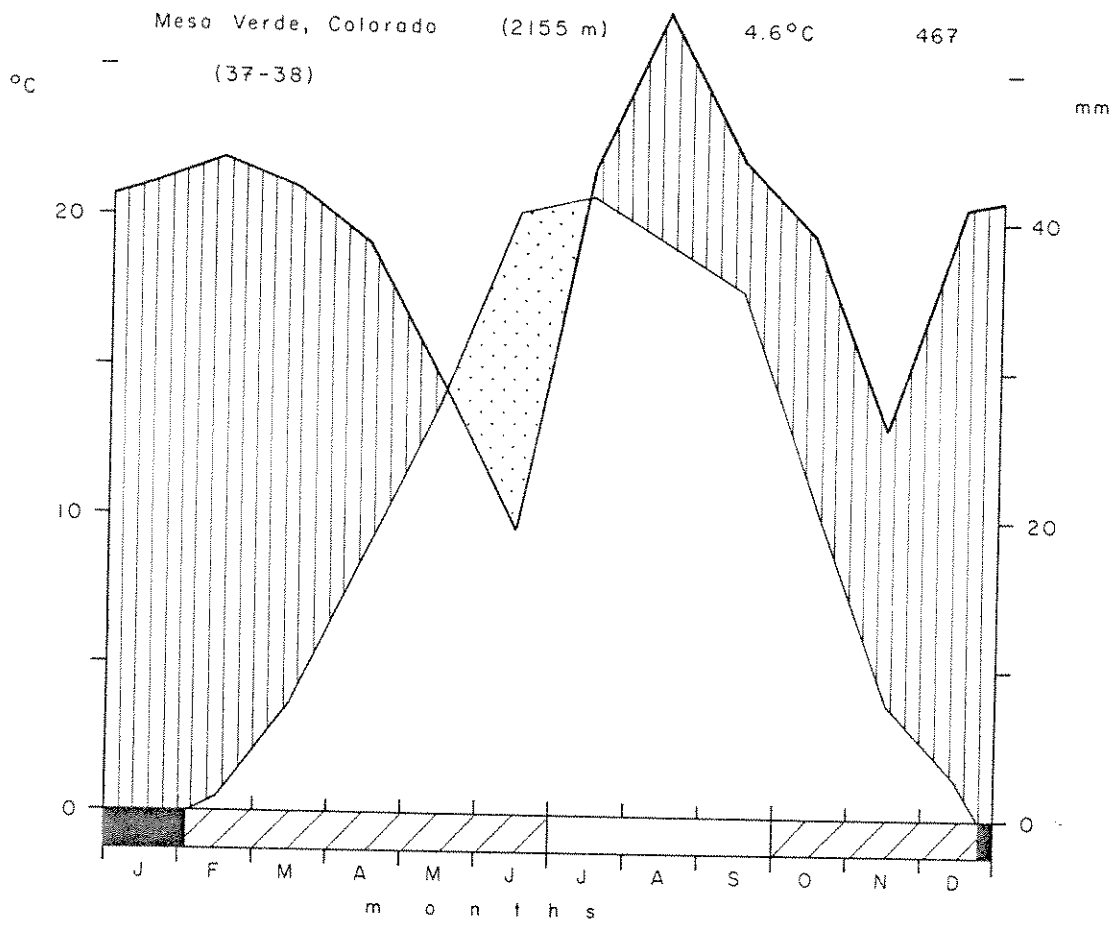

Figure I-9

Table of Contents
Tables

<u>Table Number</u>	<u>Table Heading</u>	<u>Page</u>
I-1	Natural Bridges Climatic Information	--

TABLE I-1
 NATURAL BRIDGES NATIONAL MONUMENT
 CLIMATIC INFORMATION 1965-1979

MONTH	PRECIPITATION		TEMPERATURE (Celsius)			
	Average (MM)	Average Snowfall	Average Max.	Average Min.	Record High	Record Low
January	24	24 cm	4.1 C	-8.6 C	16	-24
February	25	23 cm	7.6	-5.6	18	-18
March	24	16 cm	11.2	-3.0	23	-15
April	21	8.5 cm	15.8	+0.6	26	-14
May	15	.7 cm	23.0	4.5	29	-8
June	14	0.0 cm	26.7	9.6	38	2
July	41	0.0	32.6	15.1	40	9
August	37	0.0	30.3	13.6	37	4
September	19	0.0	25.5	9.5	34	-2
October	36	2.3 cm	18.2	3.8	28	-14
November	26	13 cm	10.0	-2.4	26	-19
December	36	38 cm	4.5	-7.5	15	-22
TOTAL (MM)	317.5	126.6 cm	17.4 C	2.5 C		
TOTAL (INCHES)	12.50	49.84	63.4 F	36.5 F		